

# Witbox *Go!*



Discover  
3D.

Guía rápida  
Guia rápido  
Quick start guide  
Guide rapide  
Kurzanleitung  
Guida rápida  
Краткая инструкция

bq

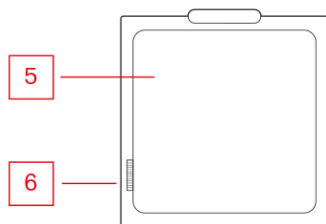
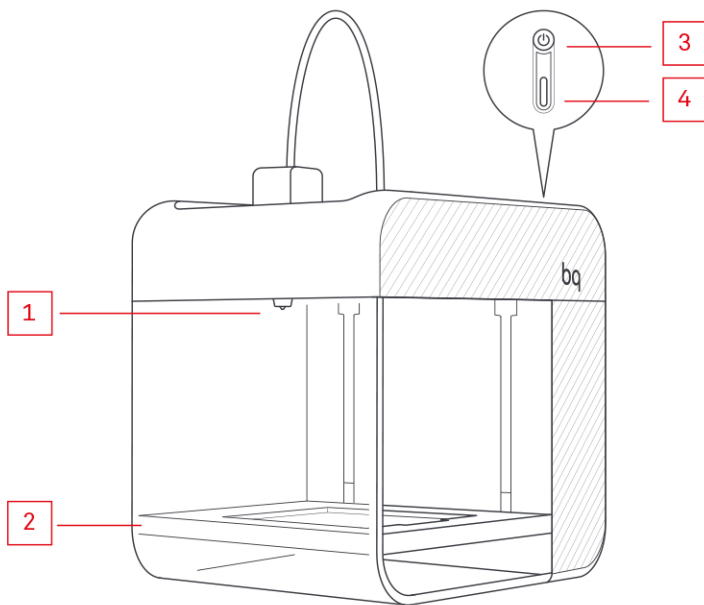

- |   |   |   |   |
|---|---|---|---|
| 1 | Boquilla   Boquilha   Nozzle   Buse   Düse<br>Ugello   Сопло  | 4 | LED de notificaciónes   LED de notificações<br>Notification LED   LED de notifiations<br>Benachrichtigungs-LED   LED di notifica<br>LED-уведомления |
| 2 | Plataforma   Plataforma   Platform<br>Plateforme   Plattform   Piattaforma<br>Платформа   | 5 | Base de impresión   Base de impressão<br>Print bed   Base d'impression   Druckbetts<br>Piano di stampa   Стол для печати                            |
| 3 | Botón encendido/apagado   Botão<br>ligar/desligar   On/OFF button   Bouton<br>marche/arrêt   Ein/Aus Knopf   Pulsante di<br>accensione/spengimento   Кнопка<br>включения / выключения | 6 | Limpiador boquilla   Limpa boquilhas<br>Nozzle cleaner   Nettoyeur de buse<br>Düsenreiniger   Gommino per pulizia ugello<br>Очиститель сопла        |

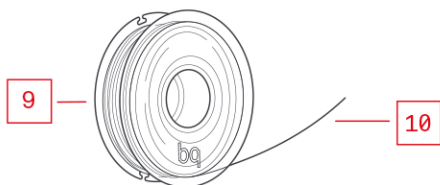
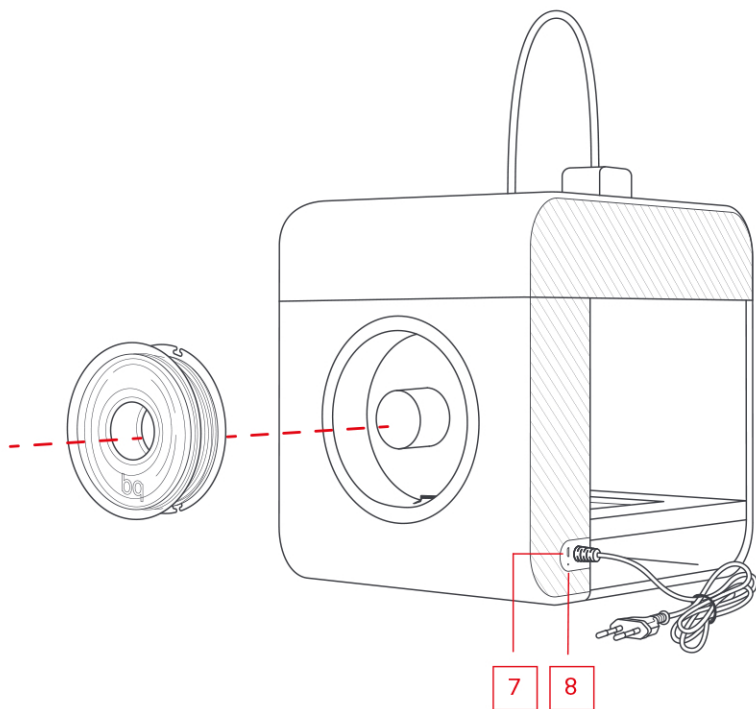

**7** Micro USB tipo B | Micro USB tipo B | Type B  
 micro USB | Micro USB type B | Micro-USB  
 Typ B | Micro-USB Typ B | Micro USB тип B

**8** Hard reset | Hard reset | Hard reset | Hard  
 reset | Hard reset | Hard reset | Аппаратн ый  
 сброс

**9** Bobina | Bobina | Spool | Spule | Bobine  
 Bobina | Катушка

**10** Filamento | Filamento | Filament | Filament  
 Filament | Filamento | филамент

Escoge el dispositivo desde el que quieres configurar tu impresora.  
Escolha o dispositivo a partir do qual deseja configurar a sua impressora.  
Choose the device that will be used to set up your printer.  
Sélectionnez le dispositif à partir duquel vous souhaitez configurer l'imprimante.  
Wähle das Gerät aus, mit dem du deinen Drucker konfigurieren möchtest.  
Scegliere il dispositivo da cui si desidera configurare la propria stampante.  
Выберите устройство, с которого вы хотите настроить ваш принтер.

**A** Smartphone | Smartphone | Smartphone | Smartphone | Smartphone  
Smartphone | Смартфон

**1.**

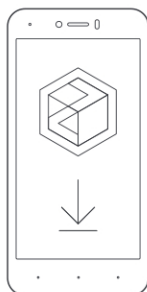

**2.**

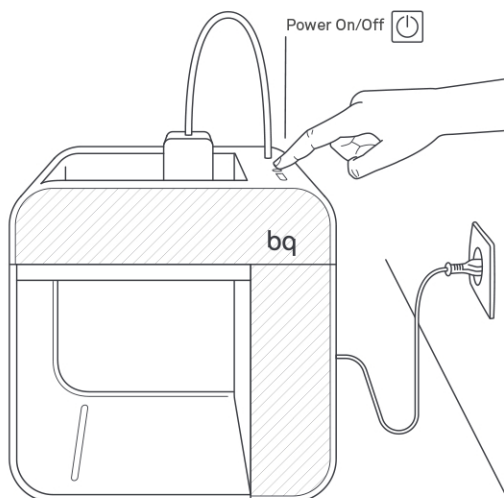

# B

Ordenador | Computador | Computer | Ordinateur | PC | Computer | Компьютер

1.

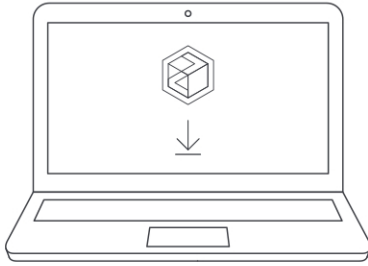

[bq.com/downloads](https://bq.com/downloads)

2.

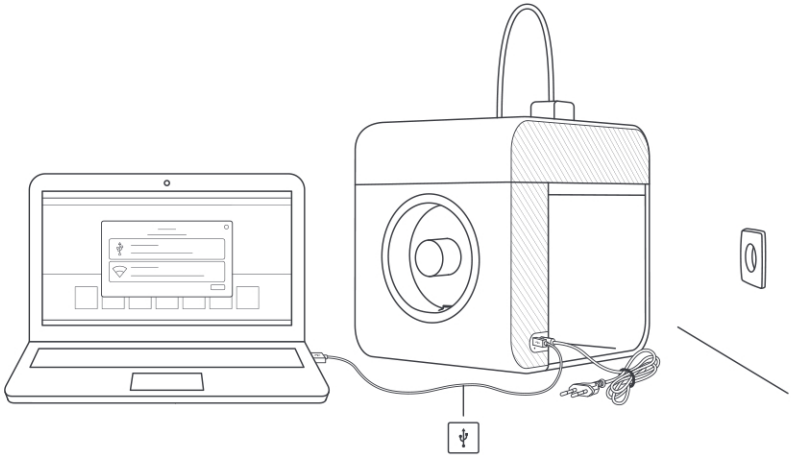

3.

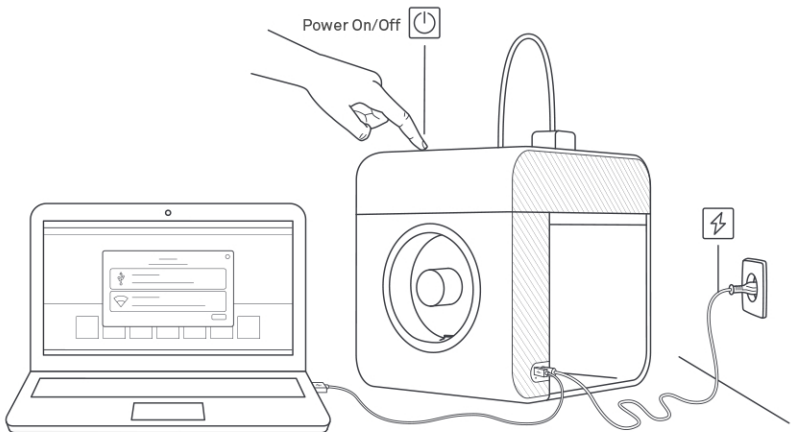

Mundo Reader, S.L.  
Pol. Ind. Európolis. C/ Sofía, 10. 28232 Las Rozas - Madrid (Spain).  
CIF:B85991941

**Commercial Brands:** BQ and Witbox are registered trademarks of Mundo Reader, S.L. Android, Google Play and the Google Play logo are trademarks of Google Inc. The Android robot is reproduced or modified from work created and shared by Google and used according to terms described in the Creative Commons 3.0 Attribution License. Qualcomm Snapdragon is a product of Qualcomm Technologies, Inc. Qualcomm and Snapdragon are trademarks of Qualcomm Incorporated, registered in the United States and other countries, used with permission.

**ES** Declaración de conformidad. Mundo Reader, S.L., declara que esta impresora 3D se ha diseñado en base a las disposiciones de la Directiva 2006/42/CE. Para acceder a la Declaración de Conformidad completa, visite [www.bq.com/downloads](http://www.bq.com/downloads)

**Empaquetado de la Witbox Go! para su transporte y/o envío a soporte técnico.** En caso de tener que enviar la impresora a nuestro Soporte técnico con motivo de alguna reparación, le recordamos que todo desperfecto que sufra el producto como consecuencia del incorrecto embalaje del mismo correrá por cuenta del Cliente, no haciéndose BQ por tanto responsable. Por ese motivo, aconsejamos conservar la caja original así como todas las protecciones que se incluyen para poder empaquetar la impresora correctamente.

**PT** Declaração de Conformidade. Mundo Reader, S.L., declara que esta impressora 3D foi concebida com base nas disposições da Diretiva 2006/42/CE. Pode consultar a Declaração de Conformidade completa em [www.bq.com/downloads](http://www.bq.com/downloads).

**Embalagem da Witbox Go! para efeitos de transporte e/ou envio para o suporte técnico.** Se tiver de enviar a sua impressora para o nosso Suporte Técnico para algum tipo de reparação, recordamos que todos os danos que o produto possa sofrer como resultado de uma embalagem incorreta do mesmo ficam por conta do Cliente, não sendo a BQ responsável por esses danos. Por esse motivo, aconselhamos a guardar a caixa original, bem como todas as proteções incluídas, para poder embalar a impressora corretamente.

**EN** Declaration of Conformity. Mundo Reader, S.L., declares that this 3D printer has been designed on the basis of the provisions contained in Directive 2006/42/EC. You can find the full Declaration of Conformity at [www.bq.com/downloads](http://www.bq.com/downloads).

**Packing the Witbox Go! for transport and/or shipment to technical support.** If the printer needs to be sent to our Technical Support for some type of repair, be aware that any damage caused to the product due to inadequate packaging will not be the responsibility of BQ, but of the Client. For this reason we recommend that the original box and all the included protectors be kept in order to properly package the printer.

**FR** Déclaration de conformité. Mundo Reader, S.L., déclare que cette imprimante 3D est conçue sur la base des dispositions de la directive 2006/42/CE. Vous pouvez consulter l'intégralité de la Déclaration de Conformité sur [www.bq.com/downloads](http://www.bq.com/downloads).

**Emballage de la Witbox Go! Pour son transport et/ou expédition au support technique.** Si vous devez expédier l'imprimante à notre Support technique, à des fins de réparation, nous vous rappelons que tout défaut constaté sur le produit résultant d'un emballage incorrect est à la charge du client, et ne relève en aucun cas de la responsabilité de BQ. Pour cette raison, nous vous conseillons de conserver l'emballage d'origine ainsi que toutes les protections qu'il contient, afin de pouvoir emballer correctement l'imprimante.

**DE** Konformitätserklärung. Mundo Reader, S.L., Erklärt, dass dieser 3D-Drucker entsprechend den Bestimmungen der Richtlinie 2006/42/EG. Die vollständige Konformitätserklärung findest du unter [www.bq.com/downloads](http://www.bq.com/downloads).

**Verpacken des Witbox Go! für den Transport und/oder Versand an den technischen Kundenservice.** Wir weisen darauf hin, falls der Drucker wegen einer Reparatur an unseren technischen Service gesendet

werden muss, dass alle Beschädigungen am Gerät, die auf schlechte Verpackung zurückzuführen sind, zu Lasten des Kunden gehen und BQ hierfür nicht verantwortlich ist. Aus diesem Grund raten wir, die Originalverpackung sowie das gesamte Schutzmaterial aufzubewahren, um den Drucker genau nach unserer Anleitung einpacken zu können.

**IT** Dichiarazione di Conformità. Mundo Reader, S.L., dichiara che questa stampante 3D è stata progettata sulla base delle disposizioni della Direttiva 2006/42/CE. È possibile consultare la Dichiarazione di Conformità completa su [www.bq.com/downloads](http://www.bq.com/downloads).

**Imballaggio della Witbox Go! per il trasporto e/o spedizione al supporto tecnico.** Nel caso in cui sia necessario spedire la stampante al nostro supporto tecnico con motivo di eventuali riparazioni, ricordiamo che i danni subiti dal prodotto a causa di un imballaggio improprio dello stesso sono a carico del cliente, senza alcuna responsabilità da parte di BQ. Per questo motivo, consigliamo di tenere la scatola originale e tutte le protezioni incluse per poter impacchettare correttamente la stampante.

**RU Декларация о соответствии.** ООО "Мундо Ридер" заявляет, что этот 3D-принтер разработан на основе положения устава 2006/42/CE. Вы можете ознакомиться с полной версией Декларации Соответствия на сайте: [www.bq.com/downloads](http://www.bq.com/downloads).

**Упаковка Witbox Go! для транспортировки и / или отправки в службу Технической поддержки.** Если Вам нужно отправить принтер в нашу службу Технической поддержки для ремонта, мы напоминаем Вам, что ответственность за любое повреждение изделия, произошедшее в результате его неправильной упаковки, будет нести заказчик, поэтому компания BQ не будет за это отвечать. В связи с этим мы рекомендуем сохранить оригинальную коробку и все вложенные средства защиты для того, чтобы правильно упаковать принтер.

Puedes encontrar toda la información y descargar las actualizaciones en nuestra web:

Pode encontrar toda a informação e transferir as atualizações na nossa página web:

You can find all the information download the updates from our website:

Rendez-vous sur notre site Internet pour retrouver toutes les informations et télécharger les mises à jour :

Du findest alle Informationen und Firmware-Aktualisierungen auf unserer Website:

Puoi trovare tutte le informazioni e scaricare gli aggiornamenti del firmware nel nostro sito Web:

Вы можете найти всю информацию и загрузить обновления на нашем сайте:



[bq.com/downloads](http://bq.com/downloads)



G008290-1.0

*eu* MADE IN EUROPE

[bq.com](http://bq.com)